

BORRELLY RONDELLES ONDULÉES

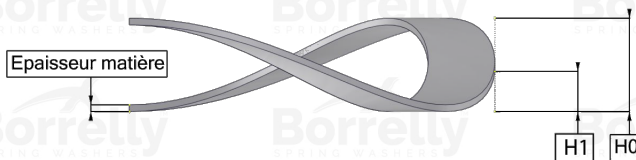

TECHNICAL SHEET PRECISION RANGE SINGLE TURN OVERLAP 17-7PH STAINLESS STEEL FOR BEARING

REFERENCE BORRELLY	OJP80S
Outer diameter of the bearing (mm)	80
Borrelly part code	RP0804J155070168
Material	Stainless steel 17-7 Ph 1.4568
Standard references for the bearing mounting on outer ring	6010 6208 6307 6405
Operates in Bore Ø min (for application other than bearing preload) (mm)	80
Clears Shaft Ø max (for application other than bearing preload) (mm)	68.4
Approximate wire section (mm)	5,5 x 0,70
Number of waves	4
Approximate free height H0 (mm)	5.7
Working height H1 (mm)	2.80
Load P1 ±15% (N)	220
Minimum working height	2 wire thickness

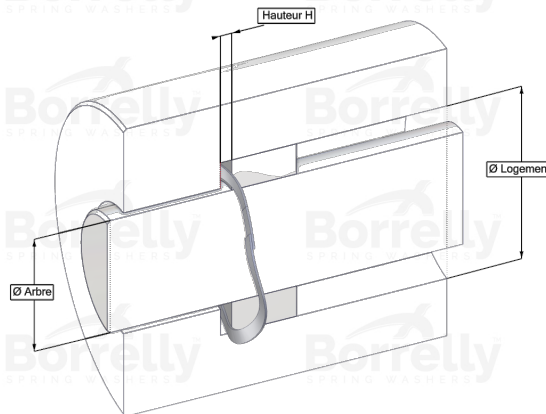
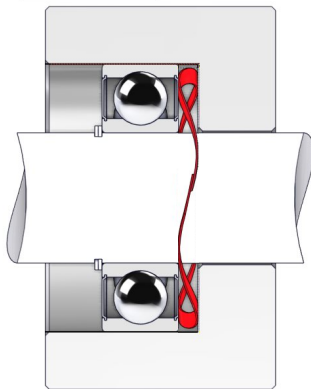