

# BORRELLY ONDUFIL WAVE SPRINGS

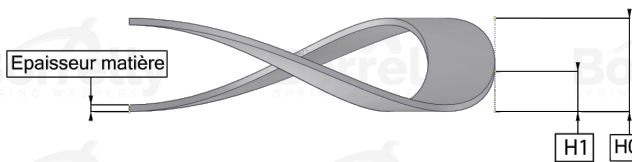

## TECHNICAL SHEET PRECISION RANGE SINGLE TURN OVERLAP 17-7PH STAINLESS STEEL FOR BEARING

REFERENCE BORRELLY	OJP75S
Outer diameter of the bearing (mm)	75
Borrelly part code	RP0754J155070168
Material	Stainless steel 17-7 Ph 1.4568
Standard references for the bearing mounting on outer ring	6009
Operates in Bore Ø min (for application other than bearing preload) (mm)	75
Clears Shaft Ø max (for application other than bearing preload) (mm)	63.4
Approximate wire section (mm)	5,5 x 0,70
Number of waves	4
Approximate free height H0 (mm)	5.0
Working height H1 (mm)	2.80
Load P1 ±15% (N)	203
Minimum working height	2 wire thickness

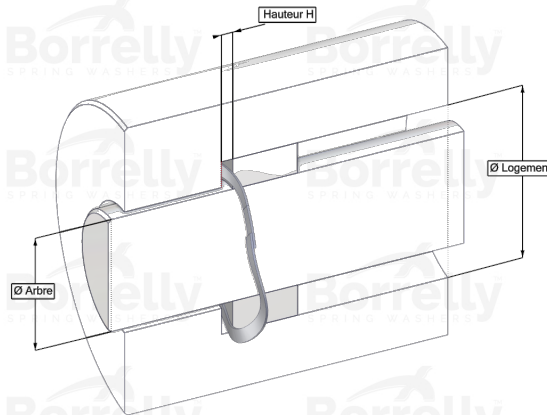
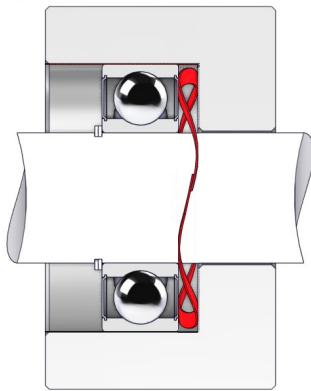