

BORRELLY ONDUFIL WAVE SPRINGS

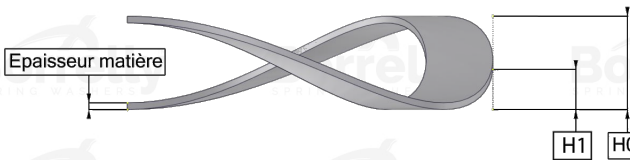

TECHNICAL SHEET PRECISION RANGE SINGLE TURN OVERLAP 17-7PH STAINLESS STEEL FOR BEARING

REFERENCE BORRELLY	OJP62S
Outer diameter of the bearing (mm)	62
Borrelly part code	RP0624J140060168
Material	Stainless steel 17-7 Ph 1.4568
Standard references for the bearing mounting on outer ring	6007 6206 6305
Operates in Bore Ø min (for application other than bearing preload) (mm)	62
Clears Shaft Ø max (for application other than bearing preload) (mm)	53.4
Approximate wire section (mm)	4,0 x 0,60
Number of waves	4
Approximate free height H0 (mm)	4.1
Working height H1 (mm)	2.35
Load P1 ±15% (N)	160
Minimum working height	2 wire thickness

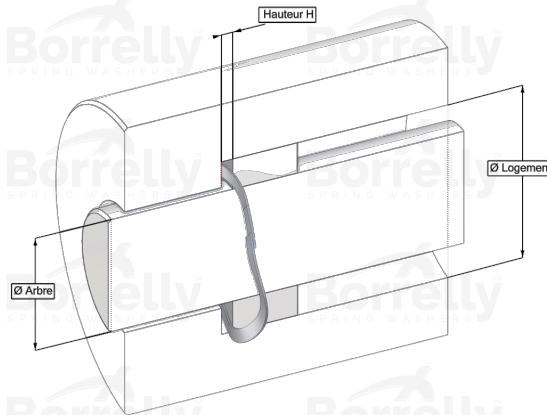