

BORRELLY RONDELLES ONDULÉES

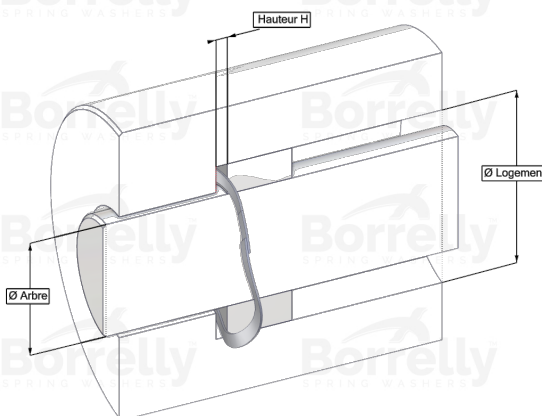
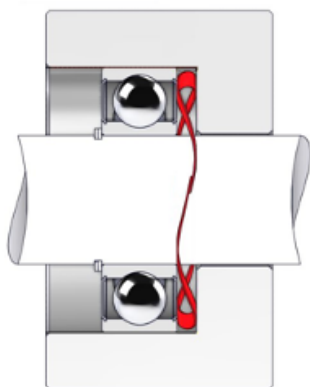

TECHNICAL SHEET STANDARD RANGE SINGLE TURN OVERLAP 17-7PH STAINLESS STEEL FOR BEARING

REFERENCE BORRELLY	OJ75S
Outer diameter of the bearing (mm)	75
Borrelly part code	RD0754J155070I68
Material	Stainless steel 17-7 Ph 1.4568
Standard references for the bearing mounting on outer ring	6009
Operates in Bore Ø min (for application other than bearing preload) (mm)	75
Clears Shaft Ø max (for application other than bearing preload) (mm)	63.4
Approximate wire section (mm)	5,5 x 0,70
Number of waves	4
Approximate free height (mm)	5.0
Recommended installation height (mm)	2.80
Approximate spring rate (N/mm)	92
Minimum working height	2 wire thickness