

BORRELLY ONDUFIL WAVE SPRINGS

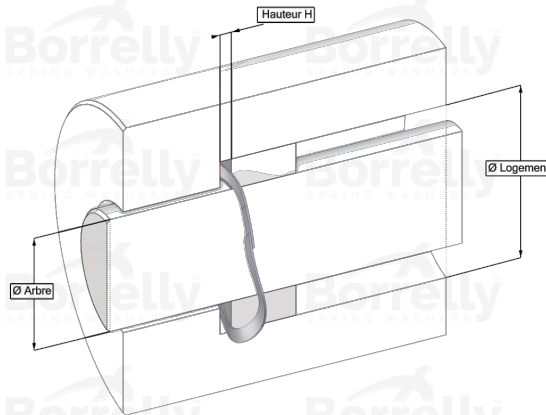
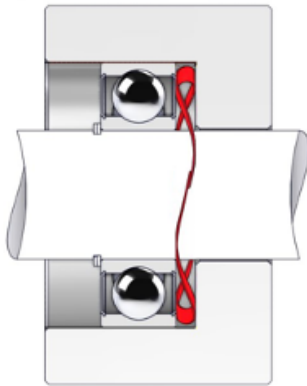

TECHNICAL SHEET STANDARD RANGE SINGLE TURN OVERLAP 17-7PH STAINLESS STEEL FOR BEARING

REFERENCE BORRELLY	OJ47S
Outer diameter of the bearing (mm)	47
Borrelly part code	RD0473J140060168
Material	Stainless steel 17-7 Ph 1.4568
Standard references for the bearing mounting on outer ring	6004 6204 6303
Operates in Bore Ø min (for application other than bearing preload) (mm)	47
Clears Shaft Ø max (for application other than bearing preload) (mm)	38.4
Approximate wire section (mm)	4,0 x 0,60
Number of waves	3
Approximate free height (mm)	4.1
Recommended installation height (mm)	2.00
Approximate spring rate (N/mm)	60
Minimum working height	2 wire thickness