

BORRELLY ONDUFIL WAVE SPRINGS

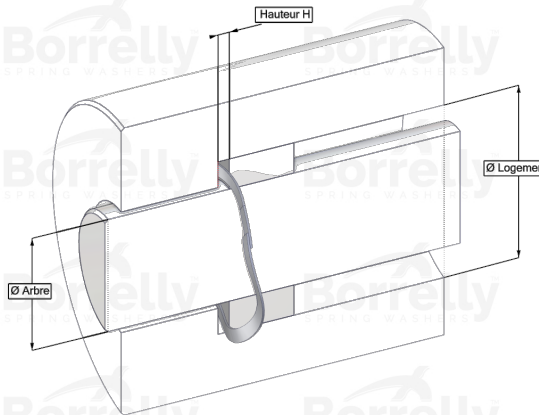
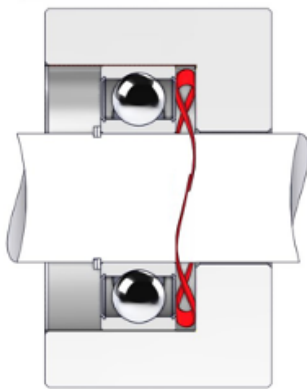

TECHNICAL SHEET STANDARD RANGE SINGLE TURN OVERLAP 17-7PH STAINLESS STEEL FOR BEARING

REFERENCE BORRELLY	OJ42S
Outer diameter of the bearing (mm)	42
Borrelly part code	RD0423J140060168
Material	Stainless steel 17-7 Ph 1.4568
Standard references for the bearing mounting on outer ring	6004 6302
Operates in Bore Ø min (for application other than bearing preload) (mm)	42
Clears Shaft Ø max (for application other than bearing preload) (mm)	33.4
Approximate wire section (mm)	4,0 x 0,60
Number of waves	3
Approximate free height (mm)	3.4
Recommended installation height (mm)	2.00
Approximate spring rate (N/mm)	82
Minimum working height	2 wire thickness