

# BORRELLY ONDUFIL WAVE SPRINGS

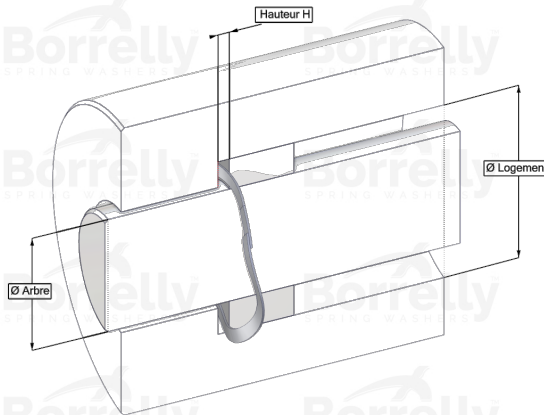
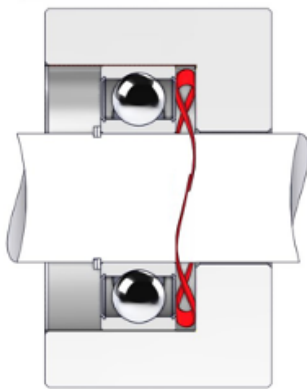

## TECHNICAL SHEET STANDARD RANGE SINGLE TURN OVERLAP 17-7PH STAINLESS STEEL FOR BEARING

REFERENCE BORRELLY	OJ30S
Outer diameter of the bearing (mm)	30
Borrelly part code	RD0303J126045168
Material	Stainless steel 17-7 Ph 1.4568
Standard references for the bearing mounting on outer ring	6200
Operates in Bore Ø min (for application other than bearing preload) (mm)	30
Clears Shaft Ø max (for application other than bearing preload) (mm)	24.4
Approximate wire section (mm)	2,6 x 0,45
Number of waves	3
Approximate free height (mm)	3.7
Recommended installation height (mm)	2.00
Approximate spring rate (N/mm)	50
Minimum working height	2 wire thickness