

BORRELLY ONDUFIL WAVE SPRINGS

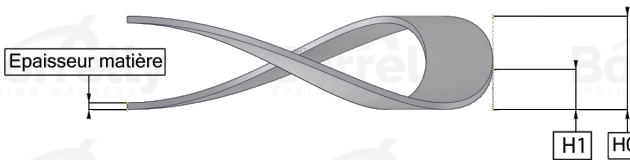

TECHNICAL SHEET PRECISION RANGE SINGLE TURN OVERLAP C75 TYPE STEEL FOR BEARING

REFERENCE BORRELLY	OJP35
Outer diameter of the bearing (mm)	35
Borrelly part code	RP0353J126045XT
Material	Carbon Steel type C75
Standard references for the bearing mounting on outer ring	6003 6202 6300
Operates in Bore Ø min (for application other than bearing preload) (mm)	35
Clears Shaft Ø max (for application other than bearing preload) (mm)	29.2
Approximate wire section (mm)	2,6 x 0,45
Number of waves	3
Approximate free height H0 (mm)	4.7
Working height H1 (mm)	2.00
Load P1 ±15% (N)	100
Minimum working height	2 wire thickness

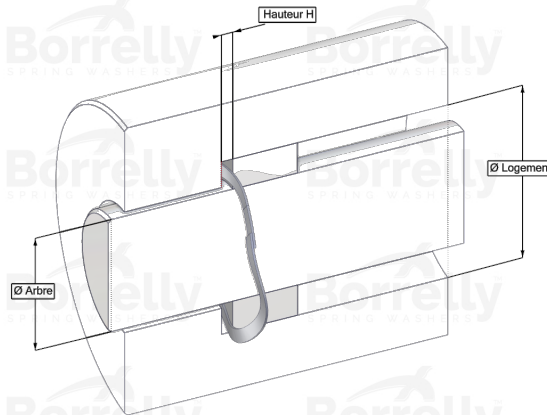
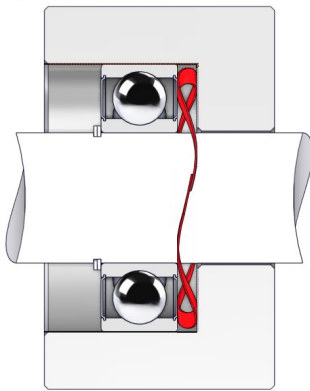