

BORRELLY ONDUFIL WAVE SPRINGS

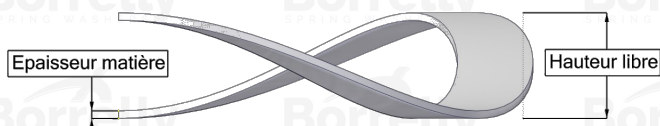
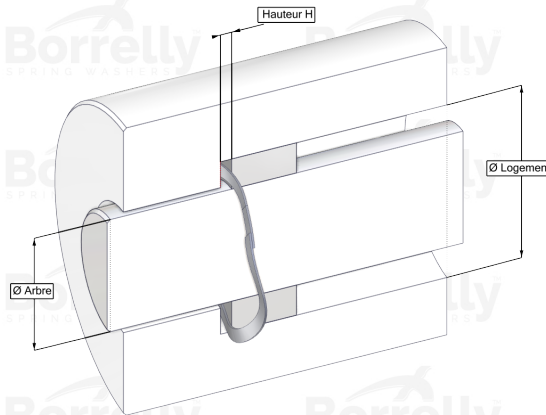

TECHNICAL SHEET STANDARD RANGE SINGLE TURN OVERLAP C75 TYPE STEEL FOR BEARING

REFERENCE BORRELLY	OJ115
Outer diameter of the bearing (mm)	115
Borrelly part code	RD1155J160080XT
Material	Carbon Steel type C75
Standard references for the bearing mounting on outer ring	60015 6015 61818
Operates in Bore Ø min (for application other than bearing preload) (mm)	115
Clears Shaft Ø max (for application other than bearing preload) (mm)	102.0
Approximate wire section (mm)	6,0 x 0,80
Number of waves	5
Approximate free height (mm)	6.1
Recommended installation height (mm)	3.20
Approximate spring rate (N/mm)	112
Minimum working height	2 wire thickness