

BORRELLY

RONDELLES ONDULÉES

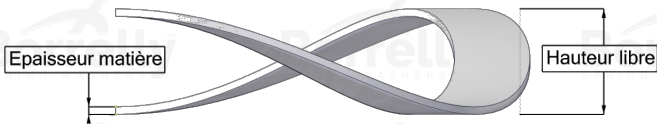
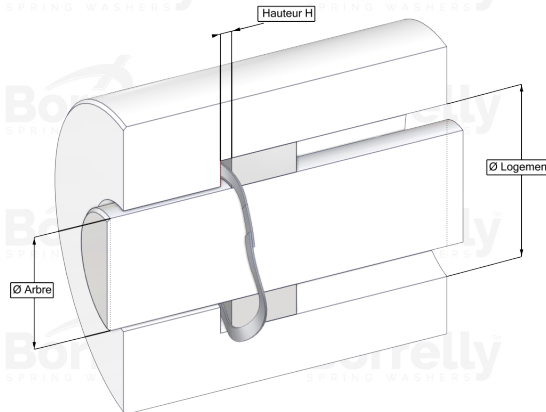
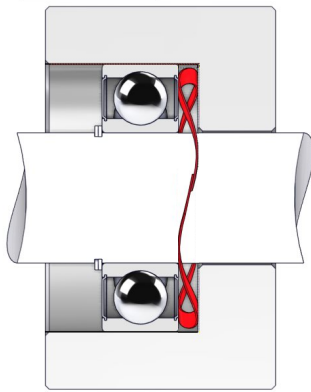

TECHNICAL SHEET STANDARD RANGE SINGLE TURN OVERLAP C75 TYPE STEEL FOR BEARING

REFERENCE BORRELLY	OJ95
Outer diameter of the bearing (mm)	95
Borrelly part code	RD0954J160080XT
Material	Carbon Steel type C75
Standard references for the bearing mounting on outer ring	6012
Operates in Bore Ø min (for application other than bearing preload) (mm)	95
Clears Shaft Ø max (for application other than bearing preload) (mm)	82.0
Approximate wire section (mm)	6,0 x 0,80
Number of waves	4
Approximate free height (mm)	6.8
Recommended installation height (mm)	2.80
Approximate spring rate (N/mm)	65
Minimum working height	2 wire thickness