

BORRELLY ONDUFIL WAVE SPRINGS

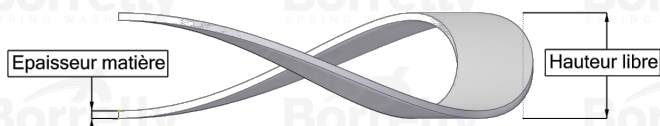
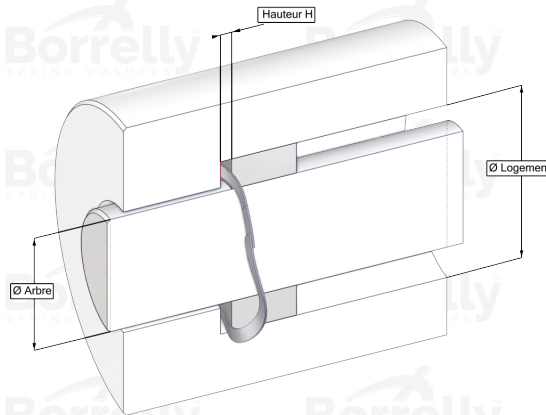
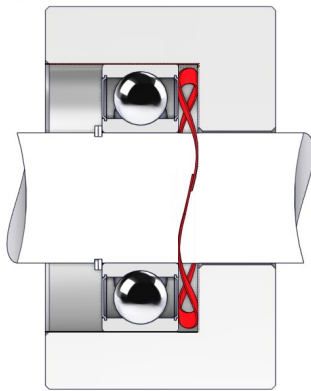

TECHNICAL SHEET STANDARD RANGE SINGLE TURN OVERLAP C75 TYPE STEEL FOR BEARING

REFERENCE BORRELLY	OJ55
Outer diameter of the bearing (mm)	55
Borrelly part code	RD0554J140060XT
Material	Carbon Steel type C75
Standard references for the bearing mounting on outer ring	6006
Operates in Bore Ø min (for application other than bearing preload) (mm)	55
Clears Shaft Ø max (for application other than bearing preload) (mm)	46.4
Approximate wire section (mm)	4,0 x 0,60
Number of waves	4
Approximate free height (mm)	3.5
Recommended installation height (mm)	2.35
Approximate spring rate (N/mm)	113
Minimum working height	2 wire thickness