

BORRELLY WAVE WASHERS

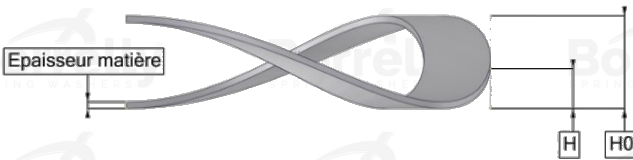

TECHNICAL SHEET C3 PRECISION RANGE 1.4310 STAINLESS STEEL FOR BEARING

REFERENCE BORRELLY	C3P340S
Outer diameter of the bearing (mm)	340
Borrelly part code	PFP338308200I10
Material	Stainless steel 1.4310
Standard references for the bearing mounting on outer ring	6238 C3
Operates in Bore Ø min (for application other than bearing preload) (mm)	340
Clears Shaft Ø max (for application other than bearing preload) (mm)	300.2
Material thickness ±10% (mm)	2.00
Number of waves	6
Approximate free height H0 (mm)	15.0
Working height H (mm)	4.0
Load ±15% (N)	4700

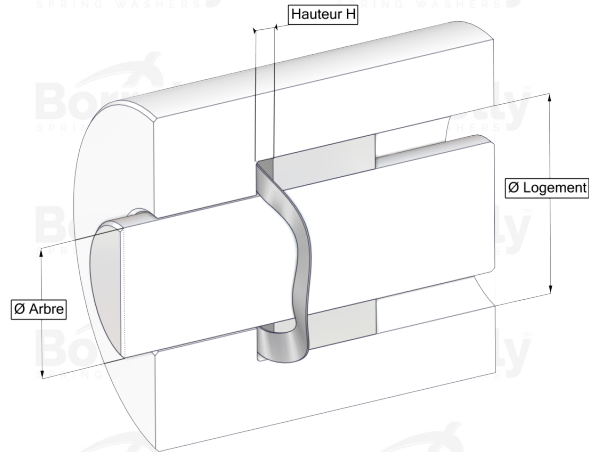
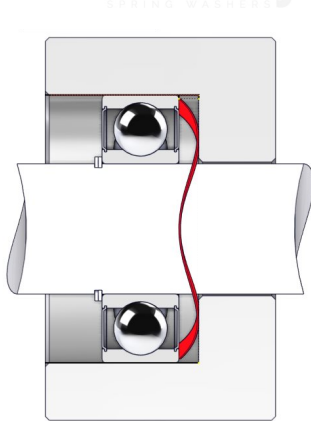