

BORRELLY WAVE WASHERS

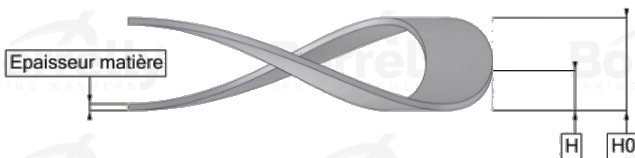
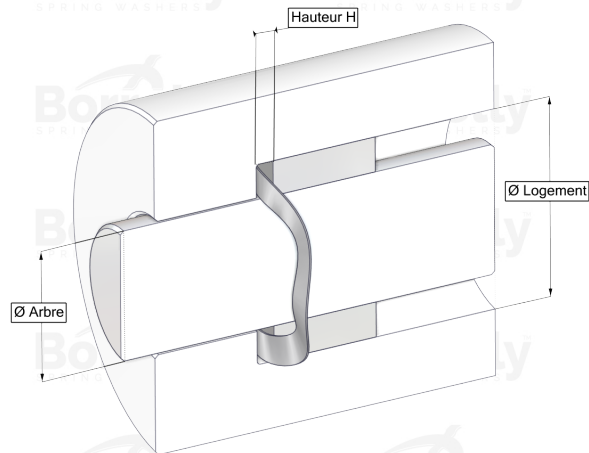

TECHNICAL SHEET C3 PRECISION RANGE 1.4310 STAINLESS STEEL FOR BEARING

REFERENCE BORRELLY

C3P110S-1

Outer diameter of the bearing (mm)	110
Borrelly part code	PEP109089080I10
Material	Stainless steel 1.4310
Standard references for the bearing mounting on outer ring	6310 C3
Operates in Bore Ø min (for application other than bearing preload) (mm)	110
Clears Shaft Ø max (for application other than bearing preload) (mm)	86.2
Material thickness ±10% (mm)	0.80
Number of waves	5
Approximate free height H0 (mm)	6.2
Working height H (mm)	4.0
Load ±15% (N)	670

