

BORRELLY WAVE WASHERS

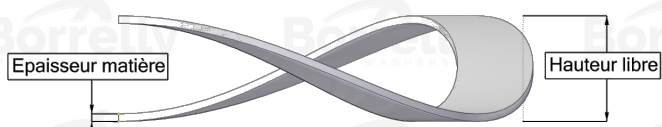
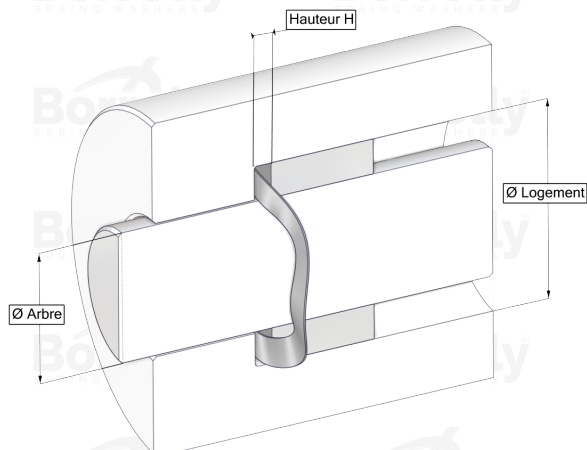
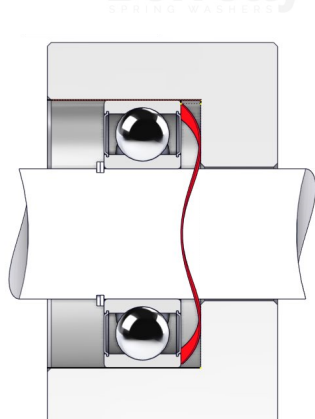

TECHNICAL SHEET C3 STANDARD RANGE 1.4310 STAINLESS STEEL FOR BEARING

REFERENCE BORRELLY	C3360S
Outer diameter of the bearing (mm)	360
Borrelly part code	PFD358328200I10
Material	Stainless steel 1.4310
Standard references for the bearing mounting on outer ring	6240 C3
Operates in Bore Ø min (for application other than bearing preload) (mm)	360
Clears Shaft Ø max (for application other than bearing preload) (mm)	318.0
Material thickness ±10% (mm)	2.00
Number of waves	6
Approximate free height H0 (mm)	18.2
Working height H for C3 bearing preload (mm)	4.0
Approximate spring rate (N/mm)	360