

BORRELLY WAVE WASHERS

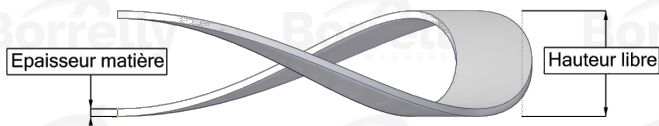
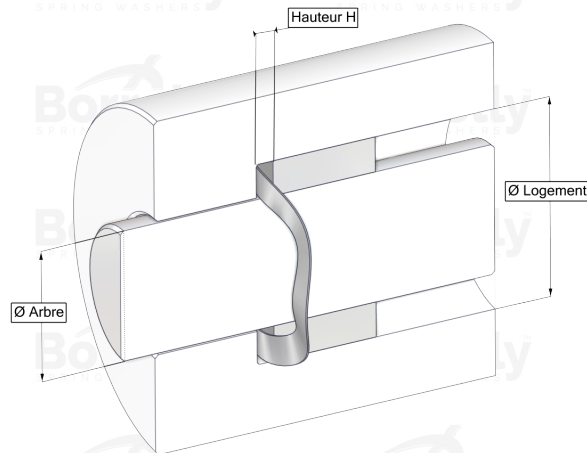

TECHNICAL SHEET C3 STANDARD RANGE 1.4310 STAINLESS STEEL FOR BEARING

REFERENCE BORRELLY	C3160S
Outer diameter of the bearing (mm)	160
Borrelly part code	PFD159139100I10
Material	Stainless steel 1.4310
Standard references for the bearing mounting on outer ring	6315 C3
Operates in Bore Ø min (for application other than bearing preload) (mm)	160
Clears Shaft Ø max (for application other than bearing preload) (mm)	136.2
Material thickness ±10% (mm)	1.00
Number of waves	6
Approximate free height H0 (mm)	5.7
Working height H for C3 bearing preload (mm)	2.5
Approximate spring rate (N/mm)	360