

BORRELLY WAVE WASHERS

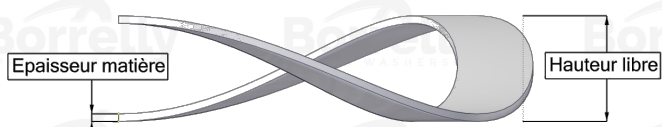
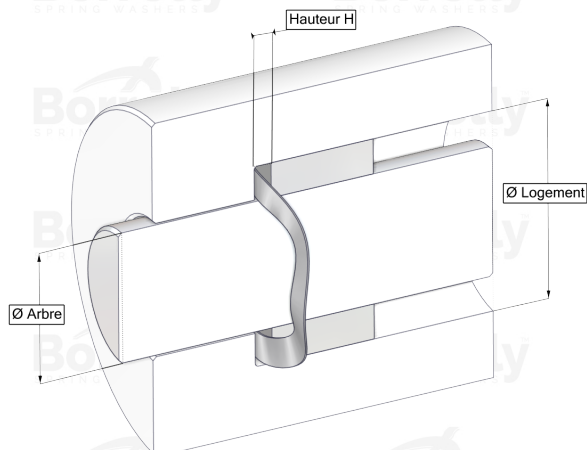
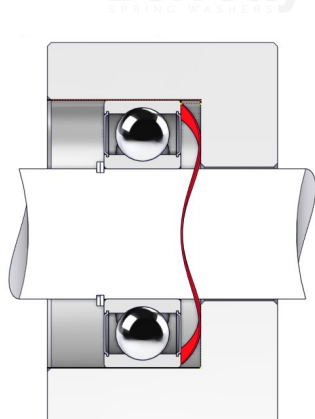

TECHNICAL SHEET C3 STANDARD RANGE 1.4310 STAINLESS STEEL FOR BEARING

REFERENCE BORRELLY	C3110S-2
Outer diameter of the bearing (mm)	110
Borrelly part code	PFD109089080I10
Material	Stainless steel 1.4310
Standard references for the bearing mounting on outer ring	6310 C3
Operates in Bore Ø min (for application other than bearing preload) (mm)	110
Clears Shaft Ø max (for application other than bearing preload) (mm)	87.3
Material thickness ±10% (mm)	0.80
Number of waves	6
Approximate free height H0 (mm)	3.2
Working height H for C3 bearing preload (mm)	2.0
Approximate spring rate (N/mm)	634