

BORRELLY WAVE WASHERS

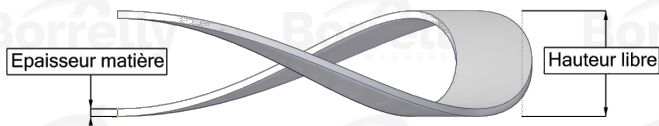
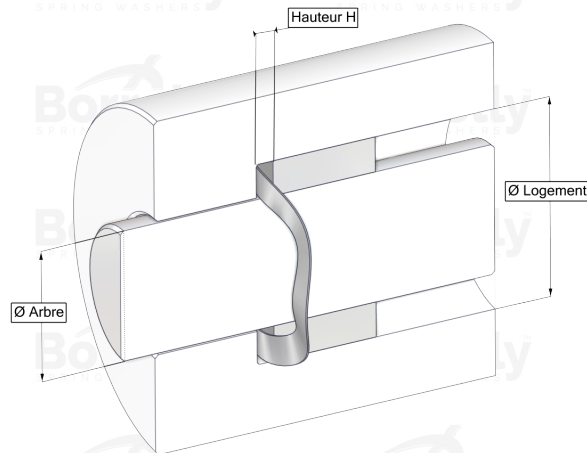

TECHNICAL SHEET C3 STANDARD RANGE 1.4310 STAINLESS STEEL FOR BEARING

REFERENCE BORRELLY	C368S
Outer diameter of the bearing (mm)	68
Borrelly part code	PFD067053035I10
Material	Stainless steel 1.4310
Standard references for the bearing mounting on outer ring	6008 C3
Operates in Bore Ø min (for application other than bearing preload) (mm)	68
Clears Shaft Ø max (for application other than bearing preload) (mm)	51.1
Material thickness ±10% (mm)	0.35
Number of waves	6
Approximate free height H0 (mm)	3.7
Working height H for C3 bearing preload (mm)	1.0
Approximate spring rate (N/mm)	163