

# BORRELLY WAVE WASHERS

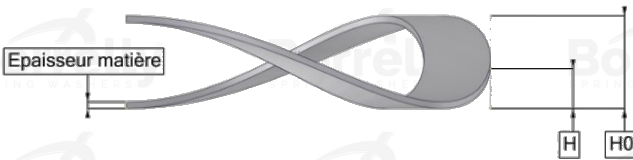

## TECHNICAL SHEET C3 PRECISION RANGE C75S STEEL FOR BEARING

REFERENCE BORRELLY	C3P110-2
Outer diameter of the bearing (mm)	110
Borrelly part code	PFP109089080XT
Material	Carbon Steel C75S 1.1248
Standard references for the bearing mounting on outer ring	6310 C3
Operates in Bore Ø min (for application other than bearing preload) (mm)	110
Clears Shaft Ø max (for application other than bearing preload) (mm)	87.3
Material thickness ±10% (mm)	0.80
Number of waves	6
Approximate free height H0 (mm)	3.0
Working height H (mm)	2.0
Load ±15% (N)	740

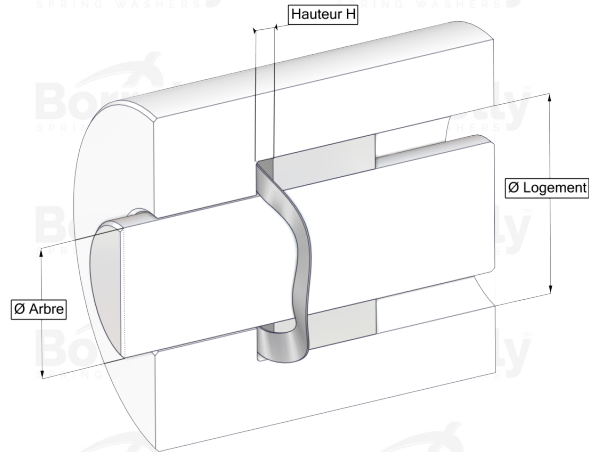
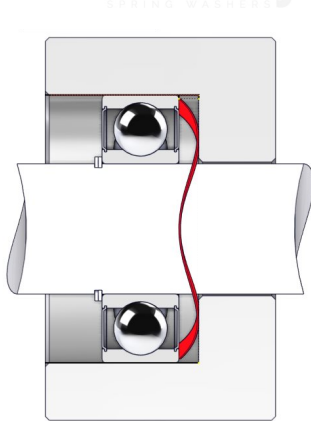