

BORRELLY WAVE WASHERS

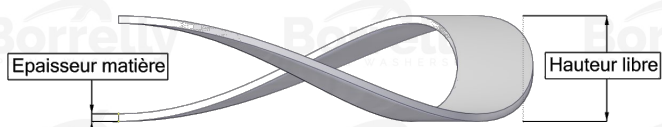
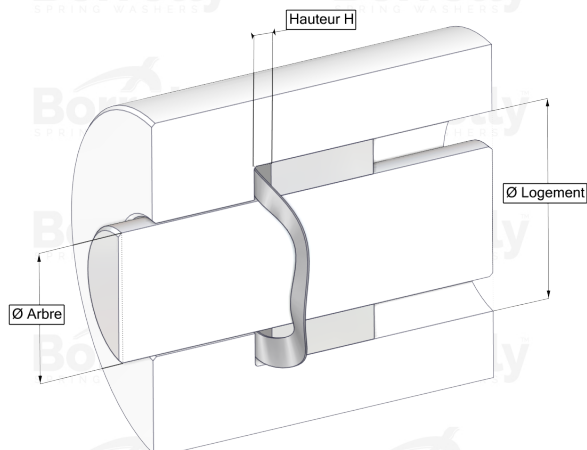
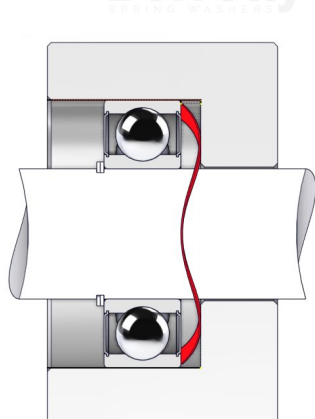

TECHNICAL SHEET C3 STANDARD RANGE C75S STEEL FOR BEARING

REFERENCE BORRELLY	C3115
Outer diameter of the bearing (mm)	115
Borrelly part code	PFD114098080XT
Material	Carbon Steel C75S 1.1248
Standard references for the bearing mounting on outer ring	6015 C3
Operates in Bore Ø min (for application other than bearing preload) (mm)	115
Clears Shaft Ø max (for application other than bearing preload) (mm)	96.1
Material thickness ±10% (mm)	0.80
Number of waves	6
Approximate free height H0 (mm)	3.6
Working height H for C3 bearing preload (mm)	2.0
Approximate spring rate (N/mm)	480