

# BORRELLY WAVE WASHERS

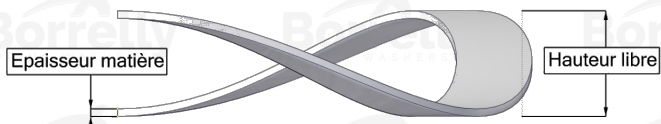
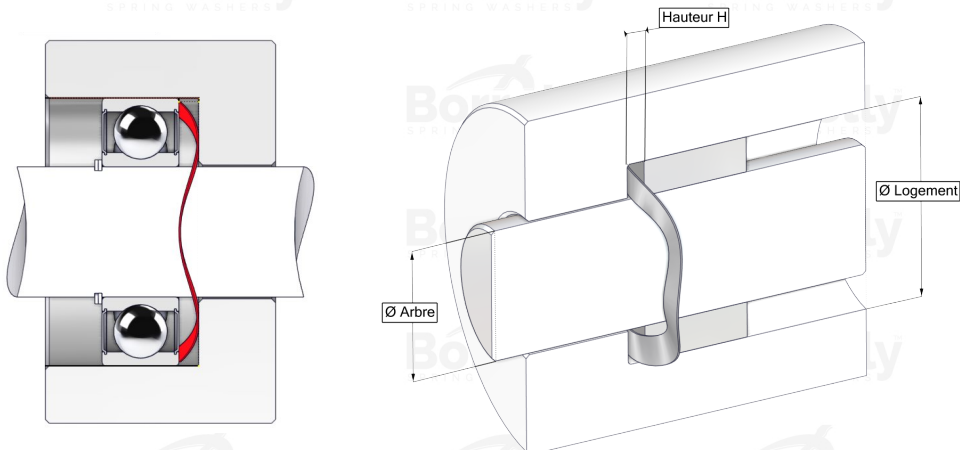

## TECHNICAL SHEET C3 STANDARD RANGE C75S STEEL FOR BEARING

REFERENCE BORRELLY	C380-2
Outer diameter of the bearing (mm)	80
Borrelly part code	PED079064060XT
Material	Carbon Steel C75S 1.1248
Standard references for the bearing mounting on outer ring	6307 C3
Operates in Bore Ø min (for application other than bearing preload) (mm)	80
Clears Shaft Ø max (for application other than bearing preload) (mm)	62.3
Material thickness ±10% (mm)	0.60
Number of waves	5
Approximate free height H0 (mm)	4.1
Working height H for C3 bearing preload (mm)	2.0
Approximate spring rate (N/mm)	290