

BORRELLY WAVE WASHERS

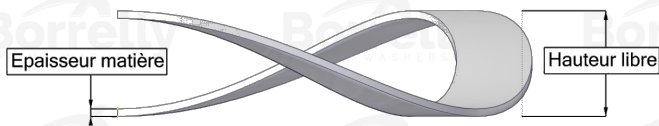
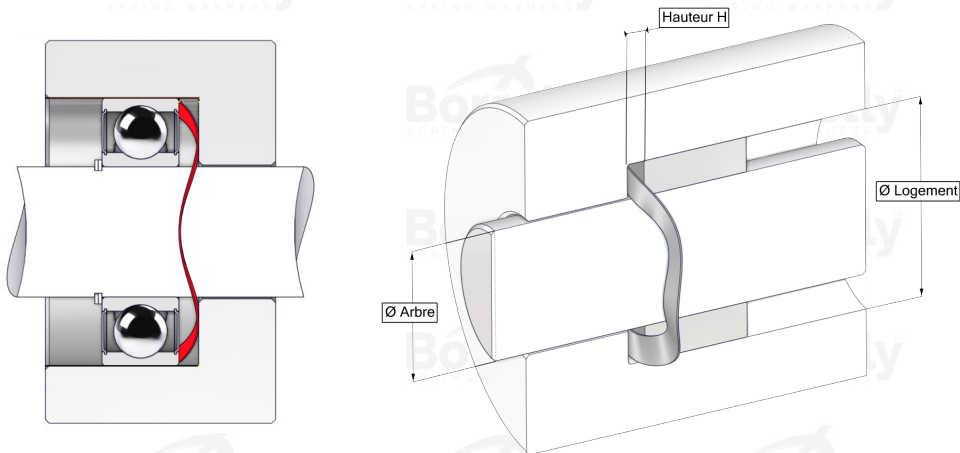

TECHNICAL SHEET C3 STANDARD RANGE C75S STEEL FOR BEARING

REFERENCE BORRELLY	C342
Outer diameter of the bearing (mm)	42
Borrelly part code	PDD041032040XT
Material	Carbon Steel C75S 1.1248
Standard references for the bearing mounting on outer ring	6302 C3
Operates in Bore Ø min (for application other than bearing preload) (mm)	42
Clears Shaft Ø max (for application other than bearing preload) (mm)	31.2
Material thickness ±10% (mm)	0.40
Number of waves	4
Approximate free height H0 (mm)	2.4
Working height H for C3 bearing preload (mm)	1.0
Approximate spring rate (N/mm)	170