

BORRELLY WAVE WASHERS

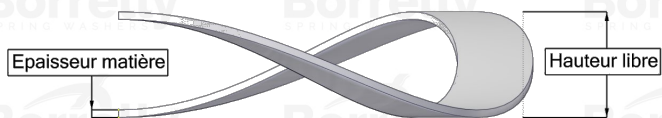
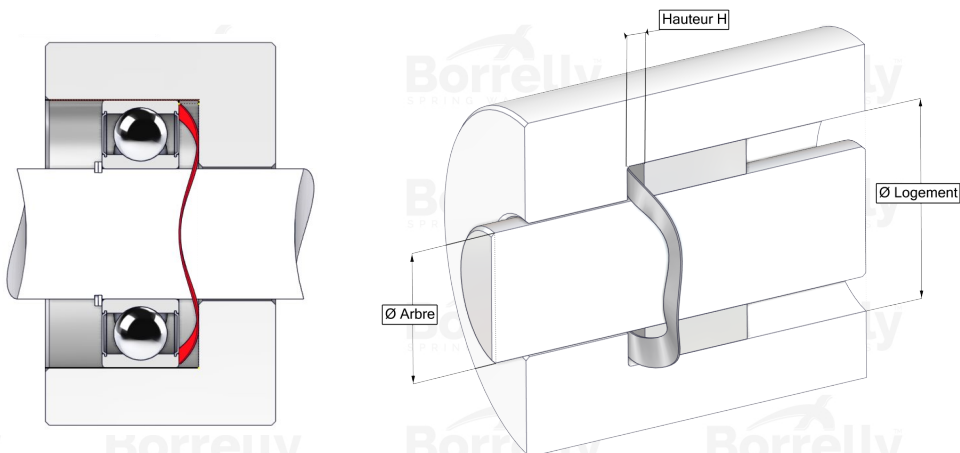

TECHNICAL SHEET CN STANDARD RANGE 1.4310 STAINLESS STEEL FOR BEARING

REFERENCE BORRELLY	CN320S
Outer diameter of the bearing (mm)	320
Borrelly part code	PDD318288200110
Material	Stainless steel 1.4310
Standard references for the bearing mounting on outer ring	6236 6330
Operates in Bore Ø min (for application other than bearing preload) (mm)	320
Clears Shaft Ø max (for application other than bearing preload) (mm)	282.7
Material thickness ±10% (mm)	2.00
Number of waves	4
Approximate free height (mm)	15.6
Working height H for CN bearing preload must be between H1 and H2 (mm)	between 5,40 and 4,00
Approximate spring rate (N/mm)	93