

# BORRELLY WAVE WASHERS

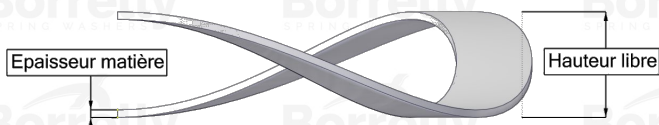
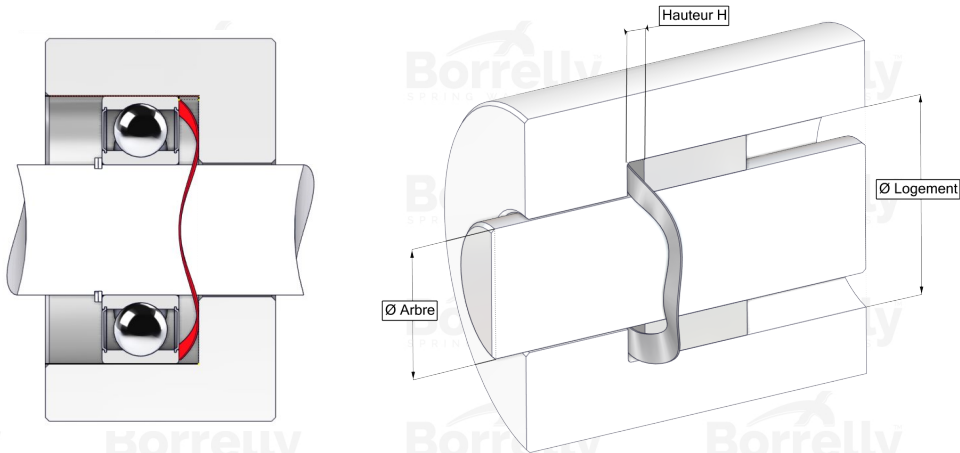

## TECHNICAL SHEET CN STANDARD RANGE 1.4310 STAINLESS STEEL FOR BEARING

REFERENCE BORRELLY	CN260S
Outer diameter of the bearing (mm)	260
Borrelly part code	PDD258228150110
Material	Stainless steel 1.4310
Standard references for the bearing mounting on outer ring	6034 6324
Operates in Bore Ø min (for application other than bearing preload) (mm)	260
Clears Shaft Ø max (for application other than bearing preload) (mm)	223.3
Material thickness ±10% (mm)	1.50
Number of waves	4
Approximate free height (mm)	14.0
Working height H for CN bearing preload must be between H1 and H2 (mm)	between 4,20 and 3,00
Approximate spring rate (N/mm)	81