

BORRELLY WAVE WASHERS

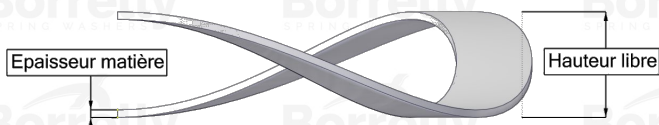
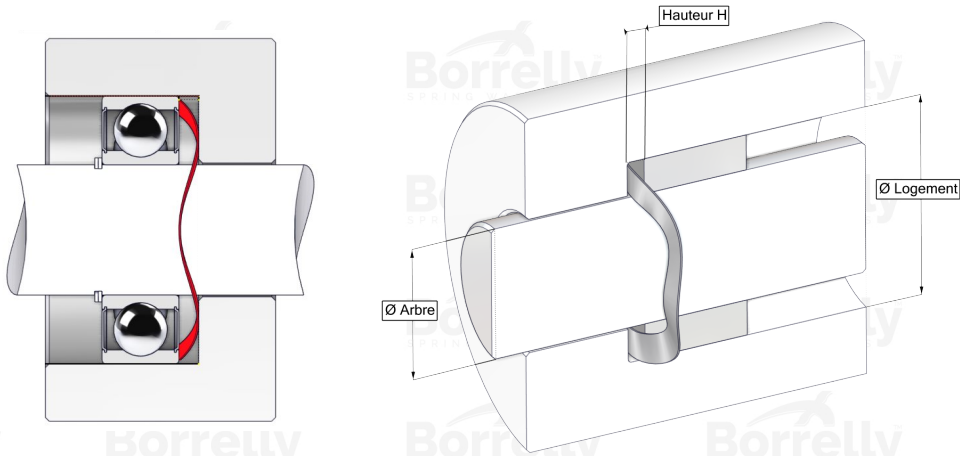

TECHNICAL SHEET CN STANDARD RANGE 1.4310 STAINLESS STEEL FOR BEARING

REFERENCE BORRELLY	CN130S
Outer diameter of the bearing (mm)	130
Borrelly part code	PDD129112080110
Material	Stainless steel 1.4310
Standard references for the bearing mounting on outer ring	6017 6215 6312 6410
Operates in Bore Ø min (for application other than bearing preload) (mm)	130
Clears Shaft Ø max (for application other than bearing preload) (mm)	109.4
Material thickness ±10% (mm)	0.80
Number of waves	4
Approximate free height (mm)	7.7
Working height H for CN bearing preload must be between H1 and H2 (mm)	between 2,20 and 1,60
Approximate spring rate (N/mm)	53