

BORRELLY WAVE WASHERS

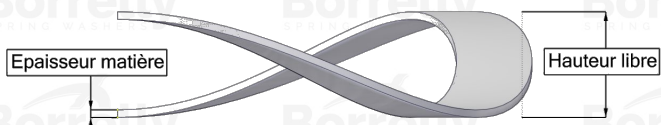
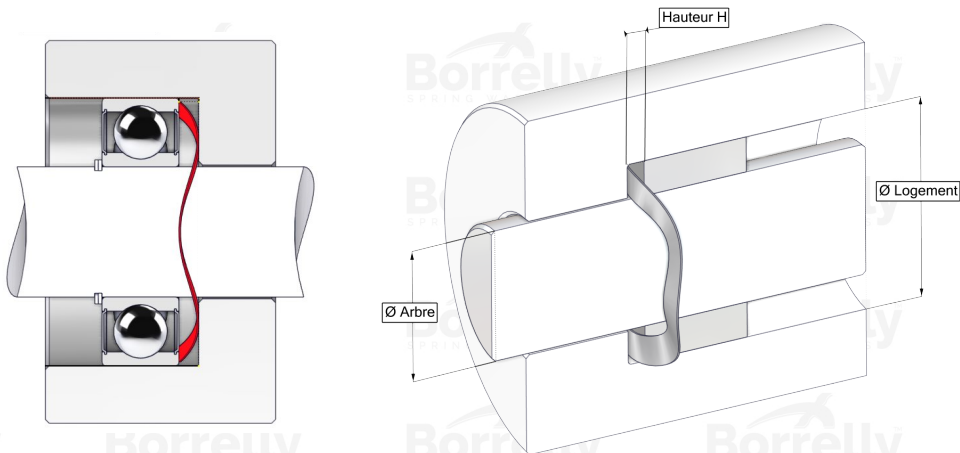

TECHNICAL SHEET CN STANDARD RANGE 1.4310 STAINLESS STEEL FOR BEARING

REFERENCE BORRELLY	CN115S
Outer diameter of the bearing (mm)	115
Borrelly part code	PDD114098080110
Material	Stainless steel 1.4310
Standard references for the bearing mounting on outer ring	6015
Operates in Bore Ø min (for application other than bearing preload) (mm)	115
Clears Shaft Ø max (for application other than bearing preload) (mm)	95.8
Material thickness ±10% (mm)	0.80
Number of waves	4
Approximate free height (mm)	6.3
Working height H for CN bearing preload must be between H1 and H2 (mm)	between 2,20 and 1,60
Approximate spring rate (N/mm)	77