

BORRELLY WAVE WASHERS

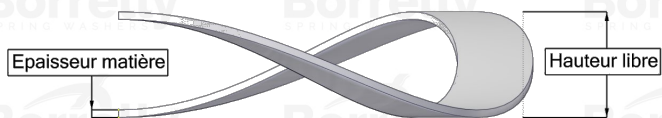
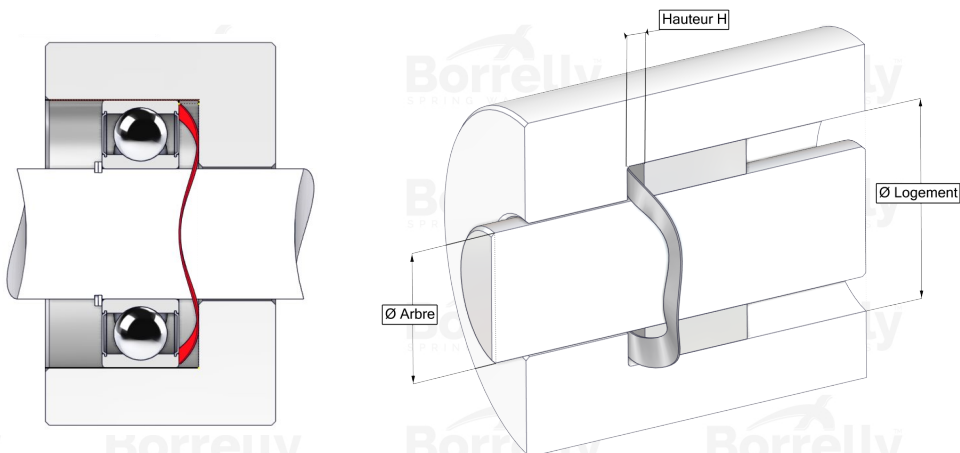

TECHNICAL SHEET CN STANDARD RANGE 1.4310 STAINLESS STEEL FOR BEARING

| REFERENCE BORRELLY | CN62SAF |
|--|------------------------|
| Outer diameter of the bearing (mm) | 62 |
| Borrelly part code | PDD061049040110 |
| Material | Stainless steel 1.4310 |
| Standard references for the bearing mounting on outer ring | 6007 6206 6305 |
| Operates in Bore Ø min (for application other than bearing preload) (mm) | 62 |
| Clears Shaft Ø max (for application other than bearing preload) (mm) | 47.0 |
| Material thickness ±10% (mm) | 0.40 |
| Number of waves | 4 |
| Approximate free height (mm) | 5.5 |
| Working height H for CN bearing preload must be between H1 and H2 (mm) | between 2,20 and 1,40 |
| Approximate spring rate (N/mm) | 43 |