

BORRELLY

RONDELLES ONDULÉES

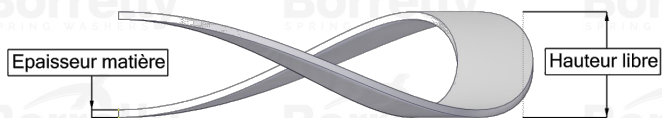
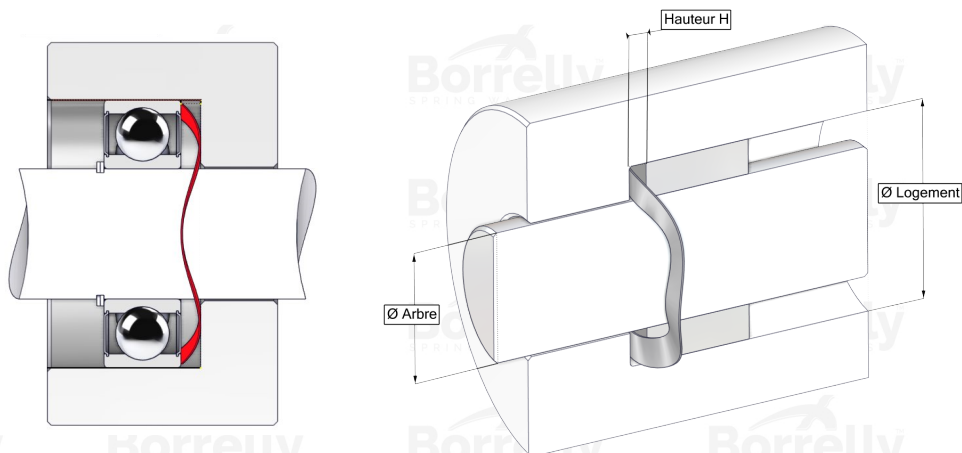

TECHNICAL SHEET CN STANDARD RANGE 1.4310 STAINLESS STEEL FOR BEARING

REFERENCE BORRELLY	CN42S
Outer diameter of the bearing (mm)	42
Borrelly part code	PDD041032025110
Material	Stainless steel 1.4310
Standard references for the bearing mounting on outer ring	6004 6302
Operates in Bore Ø min (for application other than bearing preload) (mm)	42
Clears Shaft Ø max (for application other than bearing preload) (mm)	30.4
Material thickness ±10% (mm)	0.25
Number of waves	4
Approximate free height (mm)	3.6
Working height H for CN bearing preload must be between H1 and H2 (mm)	between 1,60 and 1,00
Approximate spring rate (N/mm)	30