

# BORRELLY WAVE WASHERS

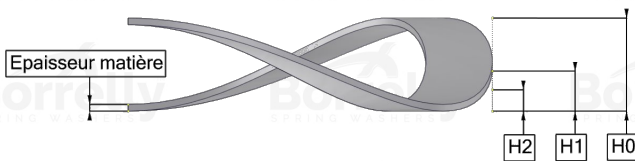

## TECHNICAL SHEET CN PRECISION RANGE 1.4310 STAINLESS STEEL FOR BEARING

REFERENCE BORRELLY	CNP340S
Outer diameter of the bearing (mm)	340
Borrelly part code	PDP338308200I10
Material	Stainless steel 1.4310
Standard references for the bearing mounting on outer ring	62 386 332
Operates in Bore Ø min (for application other than bearing preload) (mm)	340
Clears Shaft Ø max (for application other than bearing preload) (mm)	301.0
Material thickness ±10% (mm)	2.00
Number of waves	4
Approximate free height (mm)	18.5
Working height H1 (mm)	5.40
Load P1 mini(N)	884.00
Working height H2 (mm)	4.00
Load P2 maxi(N)	1345.50

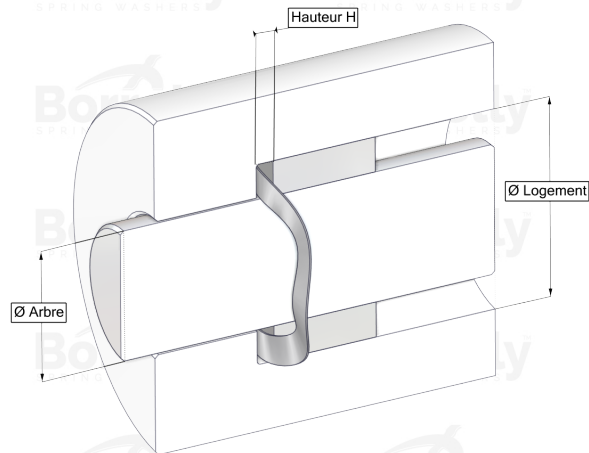
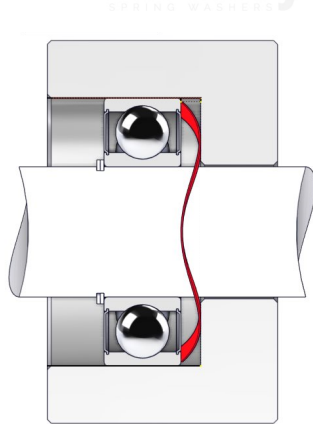