

BORRELLY WAVE WASHERS

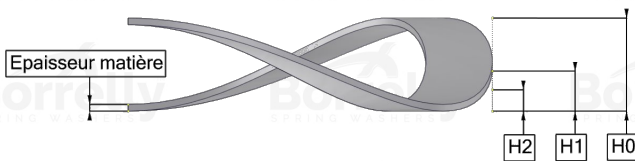

TECHNICAL SHEET CN PRECISION RANGE 1.4310 STAINLESS STEEL FOR BEARING

REFERENCE BORRELLY	CNP230S
Outer diameter of the bearing (mm)	230
Borrelly part code	PDP228203150I10
Material	Stainless steel 1.4310
Standard references for the bearing mounting on outer ring	6226
Operates in Bore Ø min (for application other than bearing preload) (mm)	230
Clears Shaft Ø max (for application other than bearing preload) (mm)	199.0
Material thickness ±10% (mm)	1.50
Number of waves	4
Approximate free height (mm)	10.9
Working height H1 (mm)	4.20
Load P1 mini(N)	467.50
Working height H2 (mm)	3.00
Load P2 maxi(N)	782.00

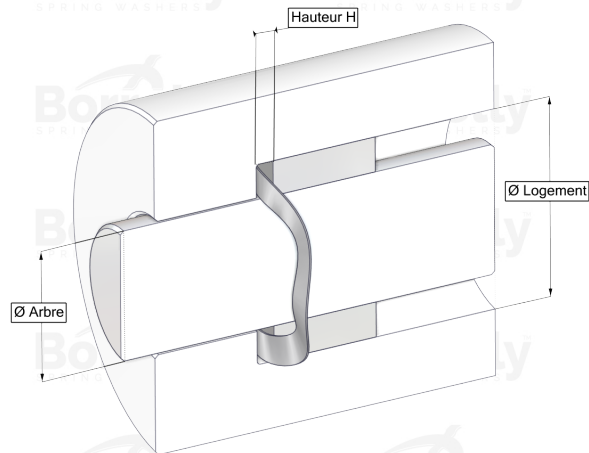