

BORRELLY

RONDELLES ONDULÉES

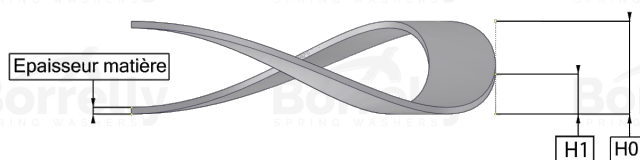
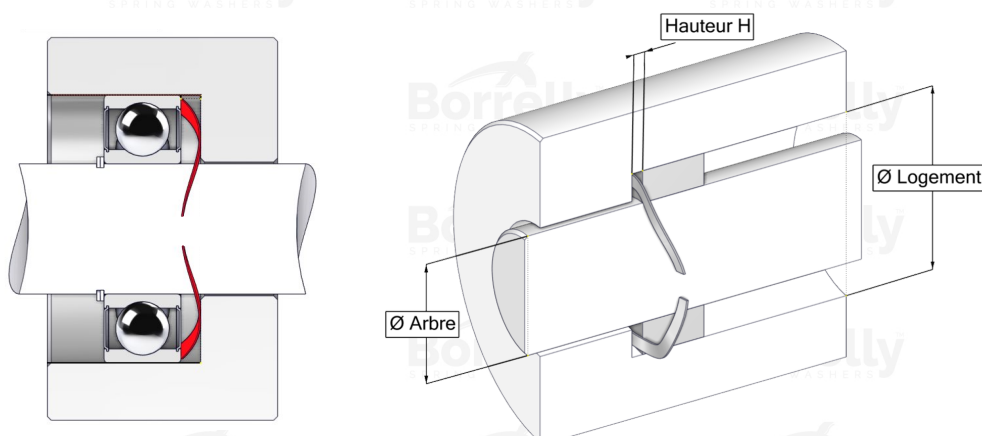

TECHNICAL SHEET PRECISION RANGE SINGLE TURN GAP 17-7PH STAINLESS STEEL FOR BEARING

REFERENCE BORRELLY	OUP115S
Outer diameter of the bearing (mm)	115
Borrelly part code	RP1155U160080I68
Material	Stainless steel 17-7 Ph 1.4568
Standard references for the bearing mounting on outer ring	60015 6015 61818
Operates in Bore Ø min (for application other than bearing preload) (mm)	115
Clears Shaft Ø max (for application other than bearing preload) (mm)	102.0
Approximate wire section (mm)	6,0 x 0,80
Number of waves	5
Approximate free height H0 (mm)	6.1
Working height H1 (mm)	3.20
Load P1 ±15% (N)	324