

BORRELLY ONDUFIL WAVE SPRINGS

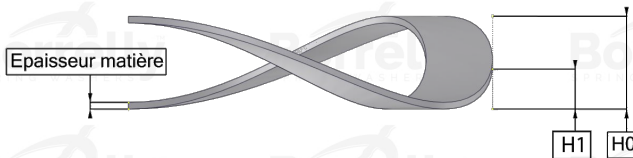
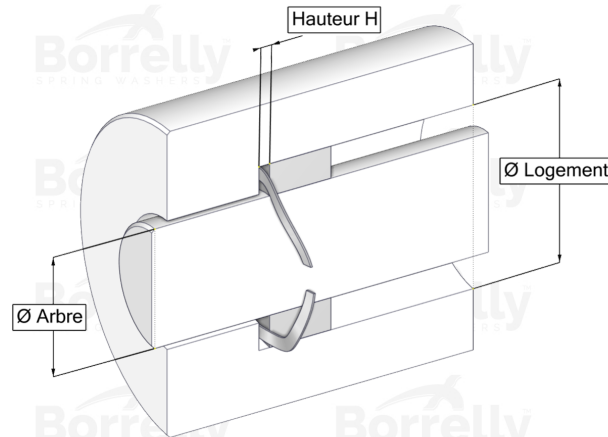
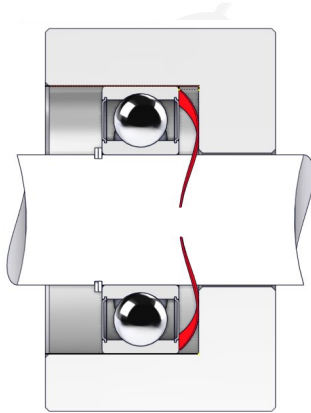

TECHNICAL SHEET PRECISION RANGE SINGLE TURN GAP 17-7PH STAINLESS STEEL FOR BEARING

REFERENCE BORRELLY	OUP68S
Outer diameter of the bearing (mm)	68
Borrelly part code	RP0684U155070I68
Material	Stainless steel 17-7 Ph 1.4568
Standard references for the bearing mounting on outer ring	6008
Operates in Bore Ø min (for application other than bearing preload) (mm)	68
Clears Shaft Ø max (for application other than bearing preload) (mm)	56.4
Approximate wire section (mm)	5,5 x 0,70
Number of waves	4
Approximate free height H0 (mm)	4.3
Working height H1 (mm)	2.80
Load P1 ±15% (N)	188