

BORRELLY ONDUFIL WAVE SPRINGS

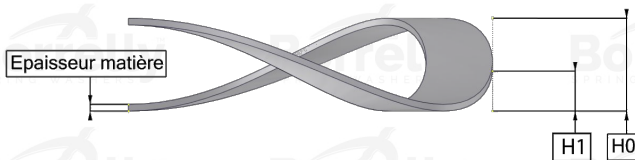
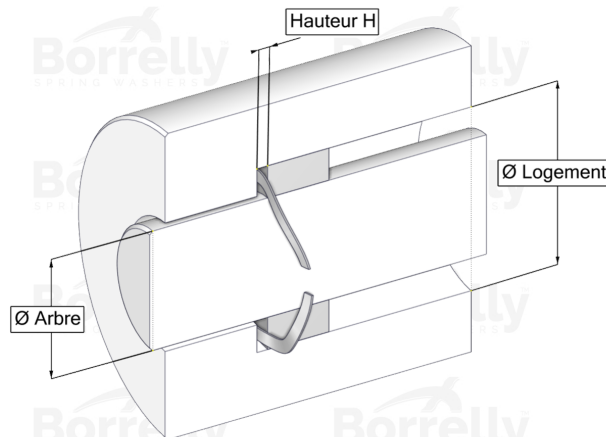
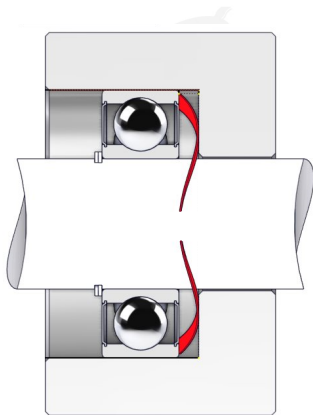

TECHNICAL SHEET PRECISION RANGE SINGLE TURN GAP 17-7PH STAINLESS STEEL FOR BEARING

REFERENCE BORRELLY	OUP55S
Outer diameter of the bearing (mm)	55
Borrelly part code	RP0554U140060I68
Material	Stainless steel 17-7 Ph 1.4568
Standard references for the bearing mounting on outer ring	6006
Operates in Bore Ø min (for application other than bearing preload) (mm)	55
Clears Shaft Ø max (for application other than bearing preload) (mm)	46.4
Approximate wire section (mm)	4,0 x 0,60
Number of waves	4
Approximate free height H0 (mm)	3.5
Working height H1 (mm)	2.35
Load P1 ±15% (N)	130