

# BORRELLY

## RONDELLES ONDULÉES

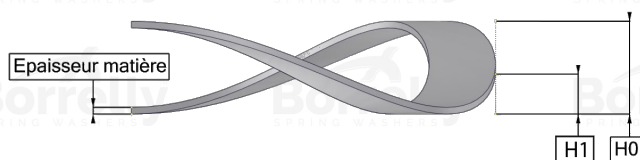
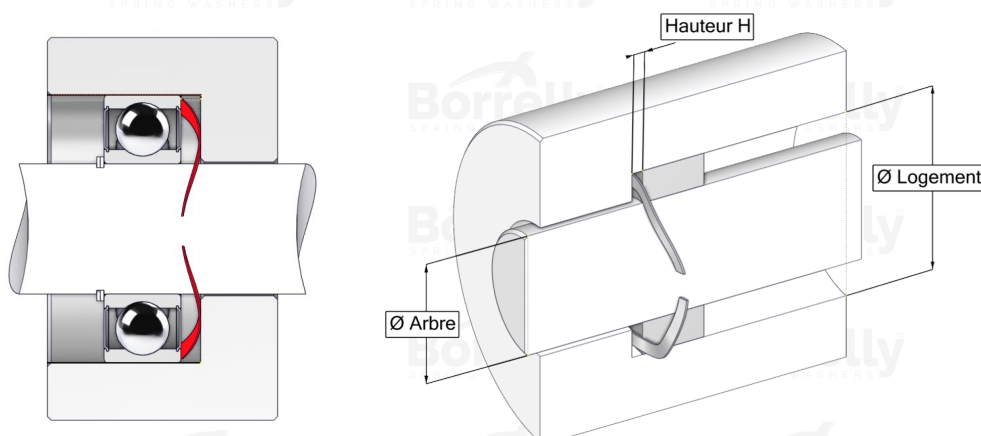

### TECHNICAL SHEET PRECISION RANGE SINGLE TURN GAP 17-7PH STAINLESS STEEL FOR BEARING

REFERENCE BORRELLY	OUP30S
Outer diameter of the bearing (mm)	30
Borrelly part code	RP0303U126045I68
Material	Stainless steel 17-7 Ph 1.4568
Standard references for the bearing mounting on outer ring	6200
Operates in Bore Ø min (for application other than bearing preload) (mm)	30
Clears Shaft Ø max (for application other than bearing preload) (mm)	24.4
Approximate wire section (mm)	2,6 x 0,45
Number of waves	3
Approximate free height H0 (mm)	3.7
Working height H1 (mm)	2.00
Load P1 ±15% (N)	86