

BORRELLY

RONDELLES ONDULÉES

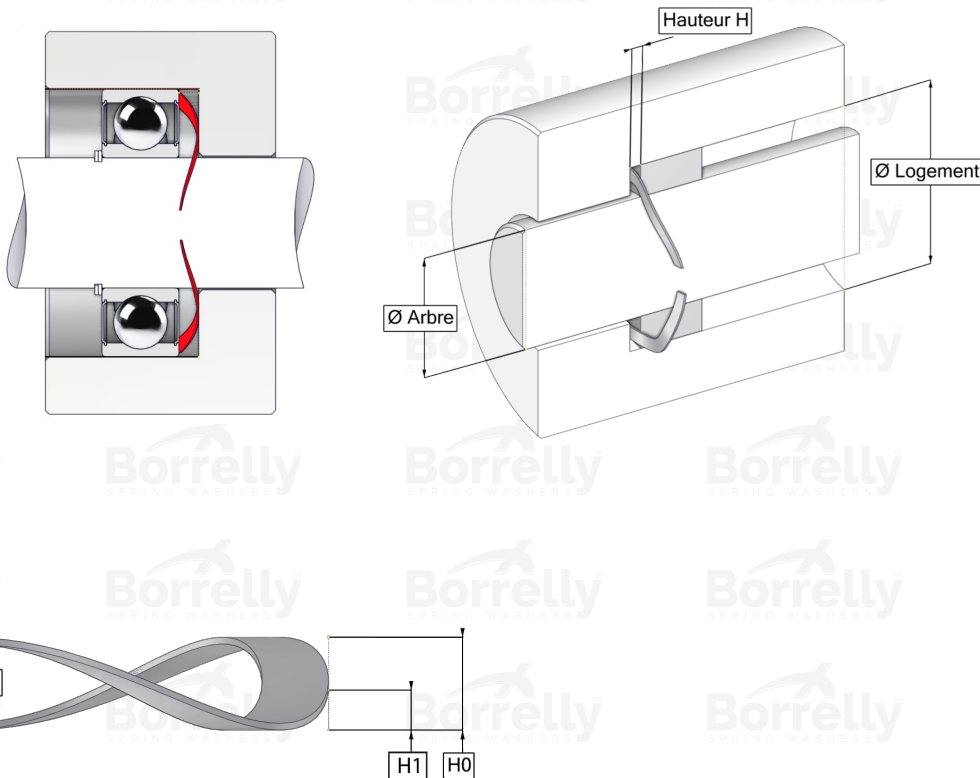

TECHNICAL SHEET PRECISION RANGE SINGLE TURN GAP 17-7PH STAINLESS STEEL FOR BEARING

REFERENCE BORRELLY	OUP28S
Outer diameter of the bearing (mm)	28
Borrelly part code	RP0283U126045I68
Material	Stainless steel 17-7 Ph 1.4568
Standard references for the bearing mounting on outer ring	6001
Operates in Bore Ø min (for application other than bearing preload) (mm)	28
Clears Shaft Ø max (for application other than bearing preload) (mm)	22.4
Approximate wire section (mm)	2,6 x 0,45
Number of waves	3
Approximate free height H0 (mm)	3.4
Working height H1 (mm)	2.00
Load P1 ±15% (N)	78