

BORRELLY ONDUFIL WAVE SPRINGS

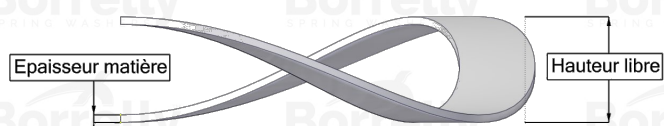
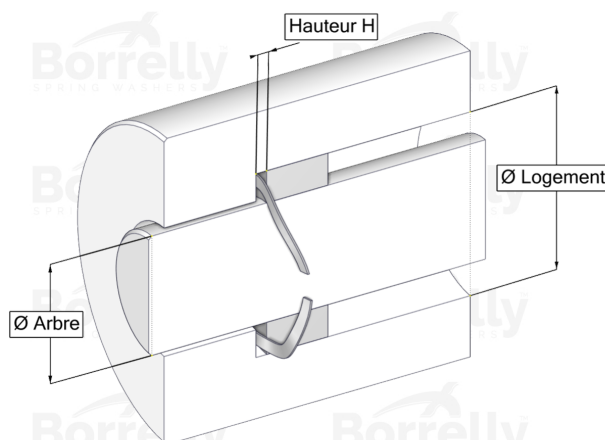
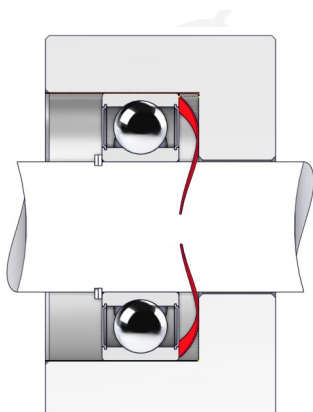

TECHNICAL SHEET STANDARD RANGE SINGLE TURN GAP 17-7PH STAINLESS STEEL FOR BEARING

REFERENCE BORRELLY	OU110S
Outer diameter of the bearing (mm)	110
Borrelly part code	RD1105U160080168
Material	Stainless steel 17-7 Ph 1.4568
Standard references for the bearing mounting on outer ring	6014 6211 6310 6408
Operates in Bore Ø min (for application other than bearing preload) (mm)	110.00
Clears Shaft Ø max (for application other than bearing preload) (mm)	97.0
Approximate wire section (mm)	6,0 x 0,80
Number of waves	5
Approximate free height (mm)	5.2
Recommended installation height (mm)	2.80
Approximate spring rate (N/mm)	127