

BORRELLY ONDUFIL WAVE SPRINGS

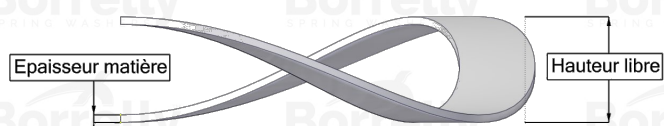
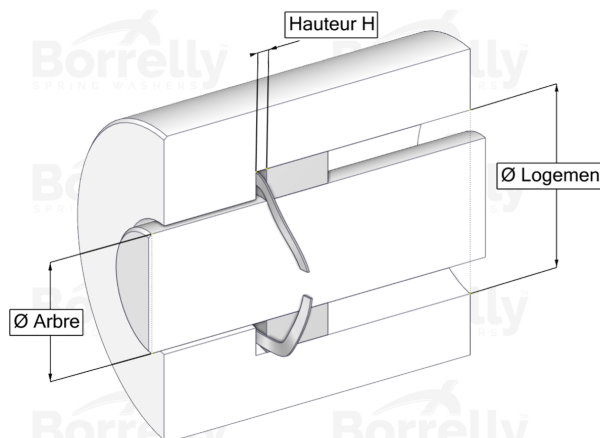
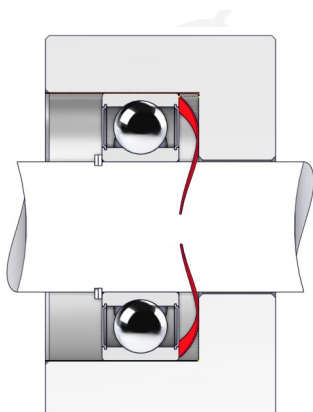

TECHNICAL SHEET STANDARD RANGE SINGLE TURN GAP 17-7PH STAINLESS STEEL FOR BEARING

REFERENCE BORRELLY	OU85S
Outer diameter of the bearing (mm)	85
Borrelly part code	RD0854U160080168
Material	Stainless steel 17-7 Ph 1.4568
Standard references for the bearing mounting on outer ring	6209
Operates in Bore Ø min (for application other than bearing preload) (mm)	85.00
Clears Shaft Ø max (for application other than bearing preload) (mm)	72.0
Approximate wire section (mm)	6,0 x 0,80
Number of waves	4
Approximate free height (mm)	5.3
Recommended installation height (mm)	2.80
Approximate spring rate (N/mm)	106