

BORRELLY ONDUFIL WAVE SPRINGS

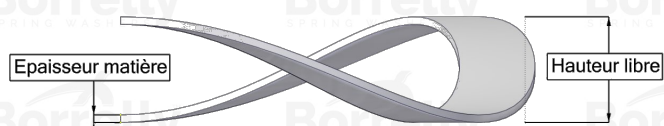
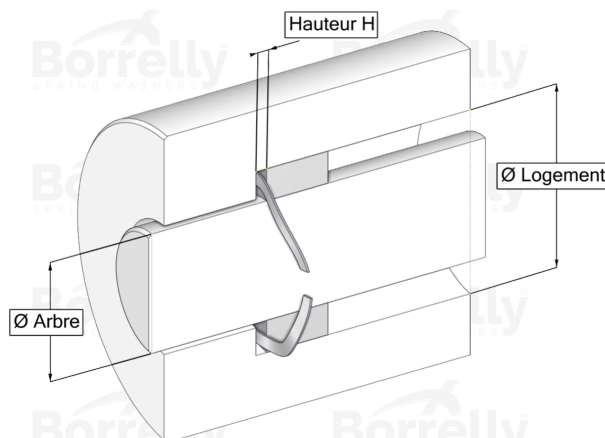
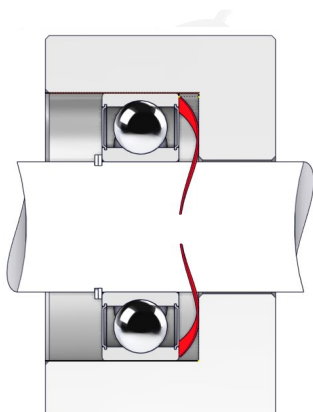

TECHNICAL SHEET STANDARD RANGE SINGLE TURN GAP 17-7PH STAINLESS STEEL FOR BEARING

REFERENCE BORRELLY	OU80S
Outer diameter of the bearing (mm)	80
Borrelly part code	RD0804U155070168
Material	Stainless steel 17-7 Ph 1.4568
Standard references for the bearing mounting on outer ring	6010 6208 6307 6405
Operates in Bore Ø min (for application other than bearing preload) (mm)	80.00
Clears Shaft Ø max (for application other than bearing preload) (mm)	68.4
Approximate wire section (mm)	5,5 x 0,70
Number of waves	4
Approximate free height (mm)	5.7
Recommended installation height (mm)	2.80
Approximate spring rate (N/mm)	76