

# BORRELLY ONDUFIL WAVE SPRINGS

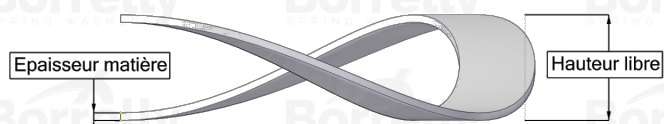
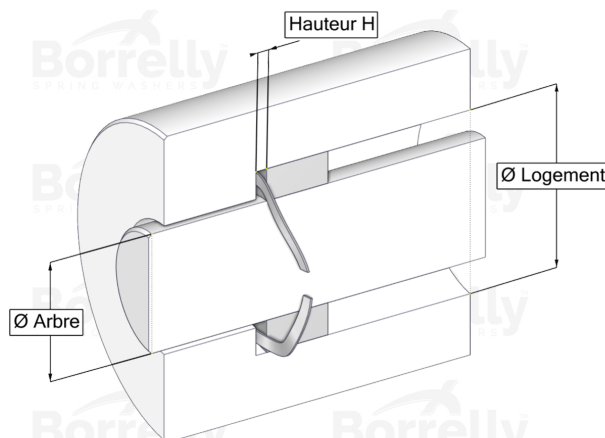
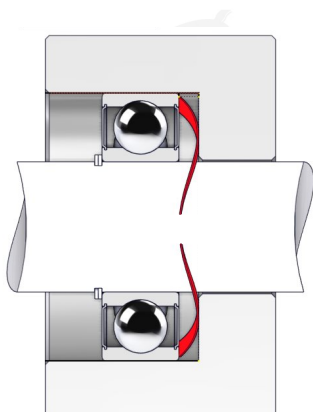

## TECHNICAL SHEET STANDARD RANGE SINGLE TURN GAP 17-7PH STAINLESS STEEL FOR BEARING

REFERENCE BORRELLY	OU40S
Outer diameter of the bearing (mm)	40
Borrelly part code	RD0403U140060I68
Material	Stainless steel 17-7 Ph 1.4568
Standard references for the bearing mounting on outer ring	6203
Operates in Bore Ø min (for application other than bearing preload) (mm)	40.00
Clears Shaft Ø max (for application other than bearing preload) (mm)	31.4
Approximate wire section (mm)	4,0 x 0,60
Number of waves	3
Approximate free height (mm)	3.1
Recommended installation height (mm)	2.00
Approximate spring rate (N/mm)	94