

BORRELLY ONDUFIL WAVE SPRINGS

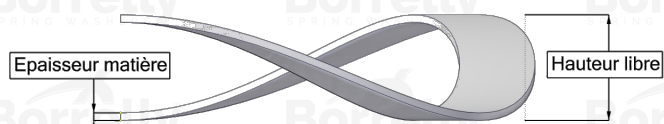
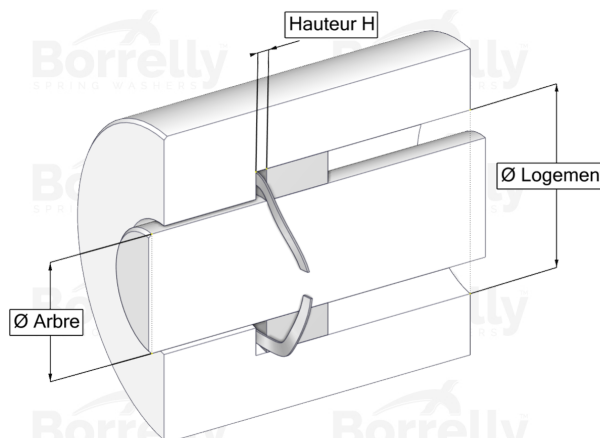
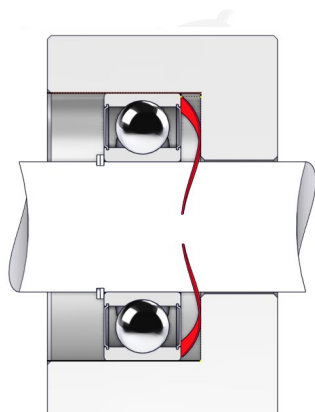

TECHNICAL SHEET STANDARD RANGE SINGLE TURN GAP 17-7PH STAINLESS STEEL FOR BEARING

REFERENCE BORRELLY	OU35S
Outer diameter of the bearing (mm)	35
Borrelly part code	RD0353U126045168
Material	Stainless steel 17-7 Ph 1.4568
Standard references for the bearing mounting on outer ring	6003 6202 6300
Operates in Bore Ø min (for application other than bearing preload) (mm)	35.00
Clears Shaft Ø max (for application other than bearing preload) (mm)	29.2
Approximate wire section (mm)	2,6 x 0,45
Number of waves	3
Approximate free height (mm)	4.7
Recommended installation height (mm)	2.00
Approximate spring rate (N/mm)	37