

BORRELLY ONDUFIL WAVE SPRINGS

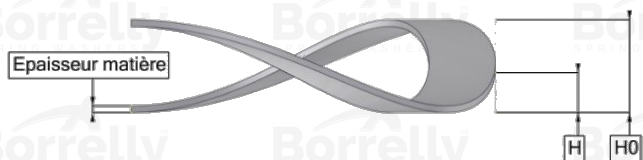
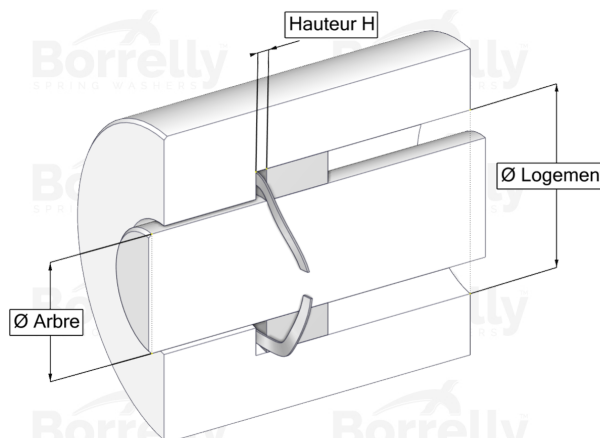
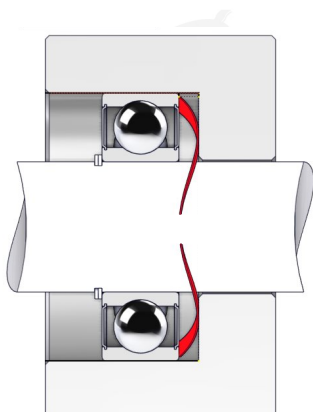

TECHNICAL SHEET PRECISION RANGE SINGLE TURN GAP C75 TYPE STEEL FOR BEARING

REFERENCE BORRELLY	OUP110
Outer diameter of the bearing (mm)	110
Borrelly part code	RP1105U160080XT
Material	Carbon Steel type C75
Standard references for the bearing mounting on outer ring	6014 6211 6310 6408
Operates in Bore Ø min (for application other than bearing preload) (mm)	110
Clears Shaft Ø max (for application other than bearing preload) (mm)	97.0
Approximate wire section (mm)	6,0 x 0,80
Number of waves	5
Approximate free height H0 (mm)	5.2
Working height H1 (mm)	2.80
Load P1 ±15% (N)	305