

BORRELLY ONDUFIL WAVE SPRINGS

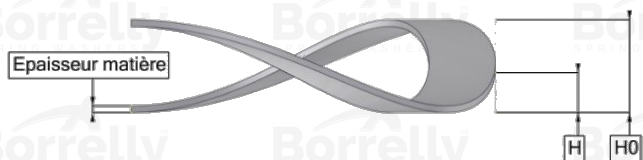
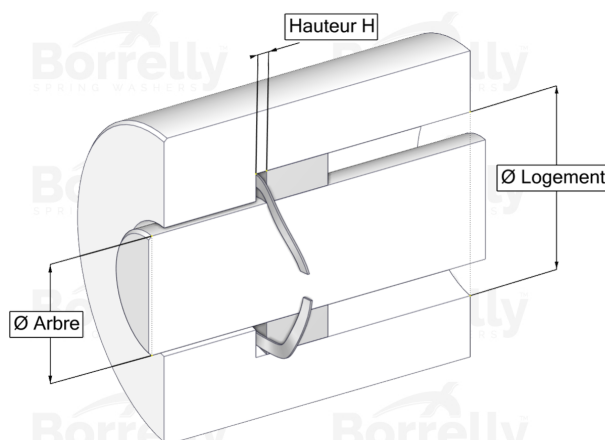
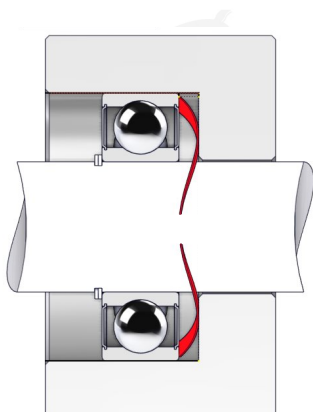

TECHNICAL SHEET PRECISION RANGE SINGLE TURN GAP C75 TYPE STEEL FOR BEARING

REFERENCE BORRELLY	OUP85
Outer diameter of the bearing (mm)	85
Borrelly part code	RP0854U160080XT
Material	Carbon Steel type C75
Standard references for the bearing mounting on outer ring	6209
Operates in Bore Ø min (for application other than bearing preload) (mm)	85
Clears Shaft Ø max (for application other than bearing preload) (mm)	72.0
Approximate wire section (mm)	6,0 x 0,80
Number of waves	4
Approximate free height H0 (mm)	5.3
Working height H1 (mm)	2.80
Load P1 ±15% (N)	266