

BORRELLY ONDUFIL WAVE SPRINGS

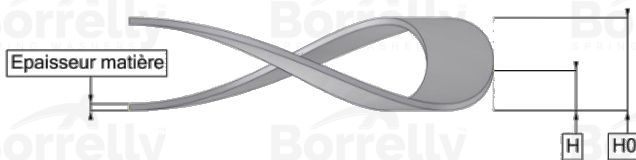
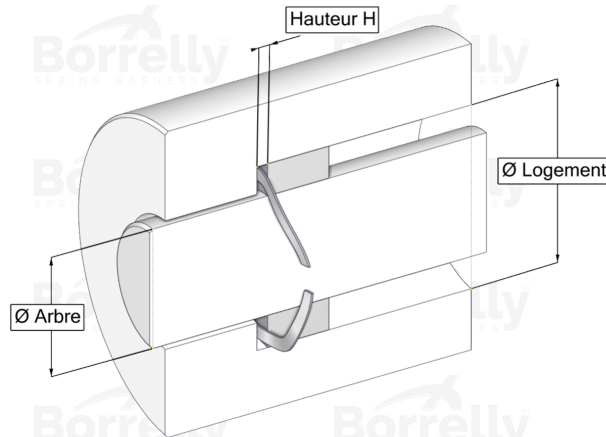
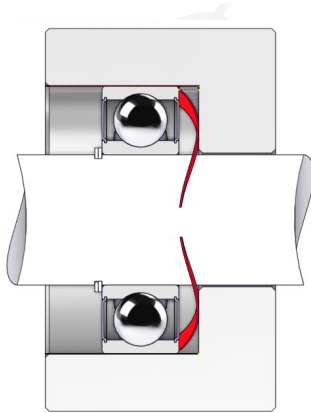

TECHNICAL SHEET PRECISION RANGE SINGLE TURN GAP C75 TYPE STEEL FOR BEARING

REFERENCE BORRELLY	OUP72
Outer diameter of the bearing (mm)	72
Borrelly part code	RP0724U155070XT
Material	Carbon Steel type C75
Standard references for the bearing mounting on outer ring	6207 6306 6404
Operates in Bore Ø min (for application other than bearing preload) (mm)	72
Clears Shaft Ø max (for application other than bearing preload) (mm)	60.4
Approximate wire section (mm)	5,5 x 0,70
Number of waves	4
Approximate free height H0 (mm)	4.6
Working height H1 (mm)	2.80
Load P1 ±15% (N)	209