

BORRELLY ONDUFIL WAVE SPRINGS

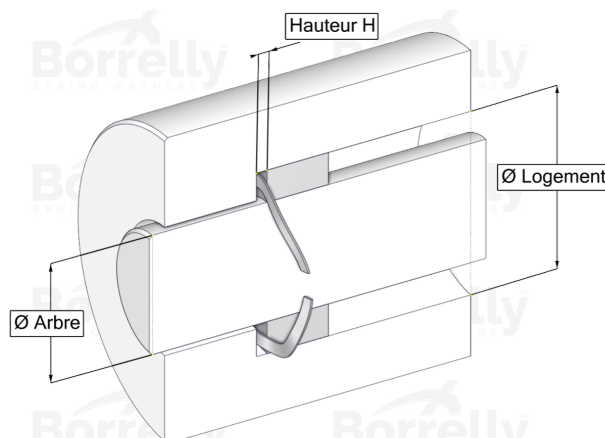
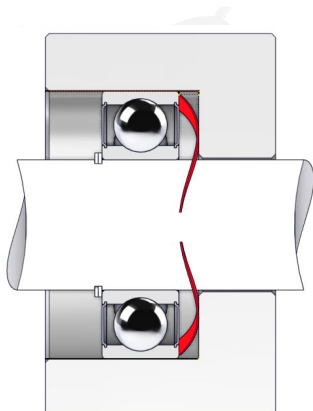

TECHNICAL SHEET STANDARD RANGE SINGLE TURN GAP C75 TYPE STEEL FOR BEARING

REFERENCE BORRELLY	OU62
Outer diameter of the bearing (mm)	62
Borrelly part code	RD0624U140060XT
Material	Carbon Steel type C75
Standard references for the bearing mounting on outer ring	6007 6206 6305
Operates in Bore Ø min (for application other than bearing preload) (mm)	62
Clears Shaft Ø max (for application other than bearing preload) (mm)	53.4
Approximate wire section (mm)	4,0 x 0,60
Number of waves	4
Approximate free height (mm)	4.1
Recommended installation height (mm)	2.35
Approximate spring rate (N/mm)	91